

THE IMPACT OF THE PRE-TENSIONING ON THE LOAD DISTRIBUTION OF TIMING BELT DRIVES

UTICAJ PRETHODNOG ZATEZANJA NA RASPODELU OPTEREĆENJA ZUPČASTIH KAIŠNIH PRENOSNIKA

Blaža Stojanović¹, Ivan Milanović¹, Saša Milojević¹, Aleksandar Skulić¹, Radomir Janjić¹

¹ Faculty of Engineering, University of Kragujevac, SERBIA, E-mail: blaza@kg.ac.rs



Abstract: The paper presents a numerical analysis of time belt drive. The finite element method (FEM) is applied for calculation of elements in this paper, timing belt and belt pulley at different load ranges. The subject of the analysis in this paper is the impact of pre-tensioning on load distribution at timing belt drive. The impact analysis of the pre-tensioning of timing belt is conducted for real timing belt drive. The timing belt drive is exposed to different values of the force of the pre-tensioning, and the results of the analysis of the timing belt drive indicate the change of the stresses in the operating conditions of the transmitter, and where the critical points are. The software package Autodesk Inventor Professional is used in analysis.

Keywords: timing belt drives, the finite element method, simulation, stress, friction

Abstract: U radu je izvršena numerička analiza zupčasto - kaišnog prenosnika. Za proračunavanje elemenata u ovom radu, zupčastog kaiša i kaišnika, pri različitim veličinama opterećenja primenjuje se metoda konačnih elemenata (MKE). Predmet analize u radu je uticaj prethodnog zatezanja na raspodelu opterećenja kod zupčasto-kaišnog prenosnika. Analiza uticaja prethodnog zatezanja zupčastog kaiša je izvršena za realni zupčasto-kaišni prenosnik. Zupčasto-kaišni prenosnik je izložen različitim vrednostima sile prethodnog zatezanja, i rezultati analize zupčasto-kaišnog prenosnika ukazuju na to kako se naponi menjaju u radnim uslovima prenosnika, i gde su kritična mesta. Pri analizi je korišćen softverski paket Autodesk Inventor Professional.

Ključne reči: zupčasti kaišni prenosnici, metoda konačnih elemenata, simulacija, napon, trenj

1. INTRODUCTION

The defining of the load distribution among the belt teeth when come in mesh with the belt pulley is of great importance for examination of timing belt drives. At the very beginning, the belt tooth was modeled, and the first model of time belt was given by Gerbert (1978), when for the first time was

introduced the friction force in the analysis of load distribution [1]. Later on are presented the results on life-time of the belt and its dependence on the load, and the defining and explanation of the noise at

power transmission, the causes of belt damage etc. In the past twenty years, the studies are aimed at simulation of the behavior of timing belt during the coupling with belt pulley and the analysis of the condition encountered. When belt is contacting belt pulley the teeth are exposed to a certain load [2].

Load distribution depends solely on the contacts, that is, elastic and friction properties of the belt, and is therefore in the construction of the belt transmitters very important to know the distribution of the load on the teeth.

Timing belt drives operate with small pre-tensioning, and examinations show that pre-tensioning is needed to overcome the resistance of bending of the belt, to compensate radial components of the resulting forces in the coupling and the resulting centrifugal force [3]. Load distribution is most commonly analyzed using Finite Element Method (FEM), which utilizes the 2D models of time belt transmitters. When analyzing the load of the timing belt drives, a number of assumptions are introduced, that is, simplifications for easier obtaining of the results.

2. TESTING OF THE TIMING BELT DRIVES

In the paper during the analysis is used timing belt with belt pulley, which is the part of the device for testing of mechanical properties of timing belt drives [4-12]. The subject of the analysis in the paper is timing belt drive marked with position 6 on the Fig. 1.

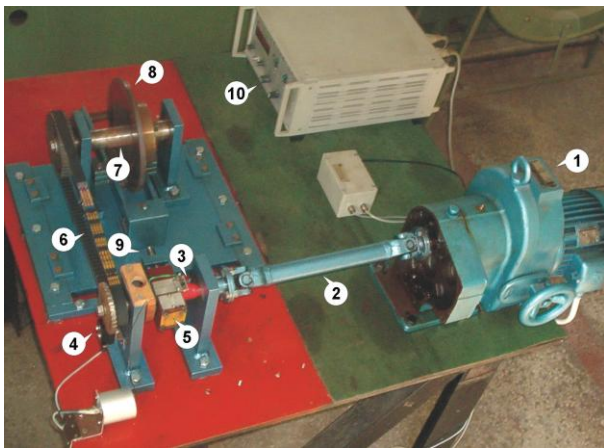

Figure 1. Test bench for testing of timing belts

The integral parts of testing device are: 1- Driving unit; 2- Cardan transmitter; 3- input shaft; 4- sensor for input shaft number of rotation; 5- torque sensor on input shaft; 6- analyzed timing belt ; 7- output shaft; 8- mechanical brake; 9- tension mechanism and 10- signal amplifier.

The basic problem in the analysis of the timing belts is the extremely complex kinematic analysis [13]. The complexity of the analysis arises primarily from the impact of the large number of parameters in the coupling. The belt tooth enters the coupling drive belt pulley maximally strained because of the force of pre-tensioning. During the coupling the top of the belt tooth makes contact with the side surface of the belt pulley tooth, and at the given moment comes to contact at line [7,8,12].

Due to interference, the belt tooth penetrates into the side surface of the belt pulley tooth, and regarding

the elastic properties of the belt and significantly greater rigidity of the belt pulley, the deformation of belt teeth occurs. The deformation of belt tooth increases with the increase of the contact surface of the belt and belt pulley [9,10]. The contact point between belt teeth and belt pulley teeth moves from the top of belt pulley tooth to its root, followed by the complete overlap of side surfaces of the teeth. The process the belt teeth meshing with the belt pulley is followed by relative sliding of its side surfaces with the occurrence of friction force [14-15].

3.FRICTION IN TIMING BELT DRIVES

The largest amount of motion and power is transferred by shape, while only a small amount is transferred by friction. The influence of friction must not, by all means, be neglected. Appearance of friction in timing belt drives and its consequences have not been thoroughly explained. In contrast to other transmissions of power and motion (gears, chain drives, cardanic transmissions, etc.) in which friction mostly occurs in the contact of the two metal surfaces, in timing belt drives, there are metal and non-metal surface or the two non-metal surfaces in the contact.

The basic tribomechanical systems in the timing belt drives are (Fig. 2) [9-12]:

- belt's tooth – belt pulley's tooth (position 1 at Fig.2.)
- belt's face – flange (position 2 at Fig.2.)
- the belt groove – apex of the belt pulley's tooth (position 2 at Fig.2.).

Types of motion that occur in these tribomechanical systems are given in Table 1.

Table 1. Tribomechanical systems and types of motion in timing belt drives (Ref. 8)

Tribomechanical system	Type of motion
belt's tooth – belt pulley's tooth	- impact
	- sliding
	- rolling
belt's face - flange	- impact
	- sliding
the belt groove – apex of the belt pulley's tooth	- sliding
	- rolling

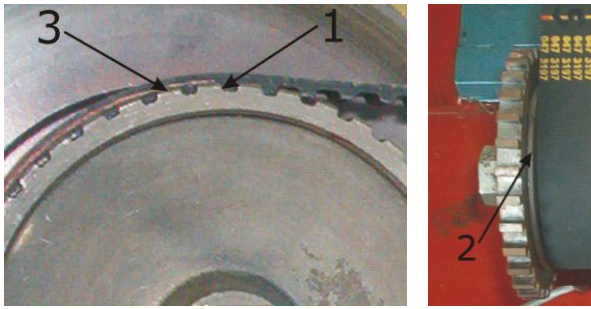

Figure 2. Tribomechanical systems in timing belt drives

The occurrence of friction at timing belt transmitters as well as their consequences have not yet been clarified, and the complex friction theory makes the examination of these resistances more difficult, and for analysis the most commonly is used the model with springs. The basic model with strings is used for interaction between the belt and belt pulley primarily because it is much simpler testing than the testing with finite elements method [16].

4. ANALYTICAL MODEL OF TIMING BELT

In the analysis of the timing belt transmitter, Fig.3, the first tooth meshing with the belt pulley is denoted as $i = 1$. Due to the increase in the angle of rotation, moving to the next position, belt tooth obtains increasing number until the last tooth in the coupling, when it is denoted as $i = n$.

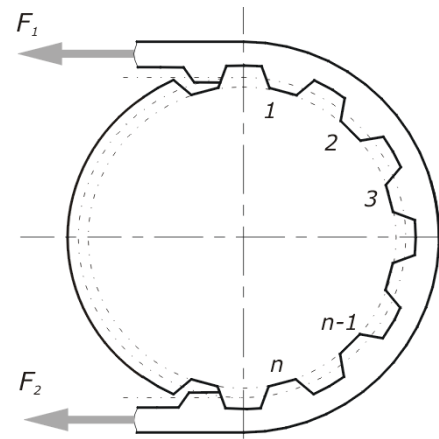

Figure 3. Belt meshing with belt pulley

Tension of the belt due to the load transmission changes from F_1 to F_2 , that is, tension in tractive and free section. Forces on the timing belt and driving pulley, which occur during the meshing, as well as the resistances i.e., friction forces, are presented on Fig.4. The procedure of belt teeth meshing with belt pulley is relatively complex and is carried out through several steps. The side of the belt tooth i from the Fig.3 is influenced by the force F_B . Force F_B has a significant impact on the load distribution; it is balanced by the forces F_{i-1}^* and F_i , and these forces intersect at the point S (Fig.4). Force F_B is calculated as:

$$F_B = F_i - F_{i-1}^* \quad (1)$$

where: F_i - force on belt tooth i ;

F_{i-1}^* - force on the tooth of $i-1$ belt pulley.

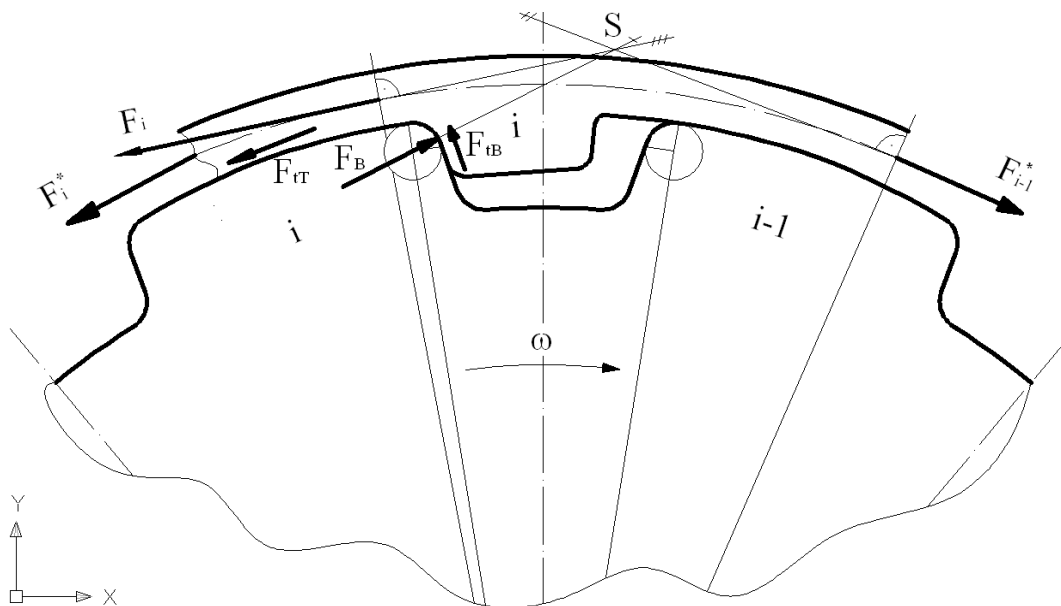

Figure 4. Forces and resistances on the belt and driving pulley due to meshing

Because of the contact of belt inter-teeth and belt pulley tooth top land, the friction force, which can be calculated in the following way, is introduced:

$$F_{iT} = F_i^* - F_i \quad (2)$$

where: F_i^* - tension force of belt teeth i ;

F_i - tension force.

An extensive force transmitted by belt tooth i according to expressions (1) and (2) can be expressed as [17]:

$$F_T = F_{iT} + F_B \quad (3)$$

Based on the identified typical places where resistances occur at meshing, for the purpose of explanation of load distribution the corresponding model with springs is formed [18]. In the previous part of the paper are mentioned two friction forces, and in such way are also positioned the springs on those typical places where resistances when moving will occur.

The simplified model of the transmitter elements, with placed springs on the places of the belt and belt pulley contacts is presented on the Fig.5

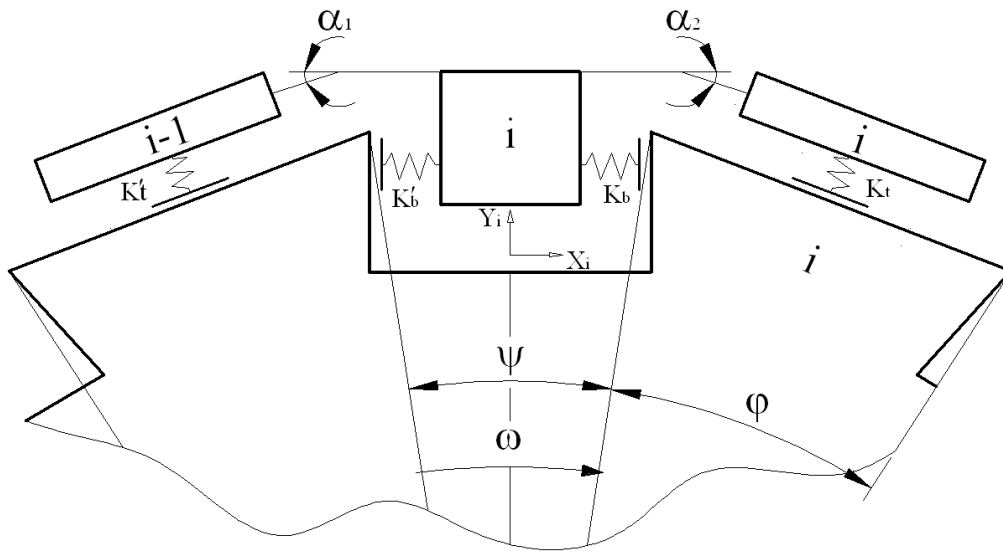

Figure 5. Basic model of the belt with belt pulley

It is important to mention that the belt pulley is significantly more rigid compared to timing belt, and due to the contact the large deformations of the belt occur. For the mode presented on Fig.4, the equilibrium equations are established. Equilibrium equations are very complex for calculation, therefore is necessary to adopt certain simplifications in order to obtain results. Therefore, if it is adopted that angles α_1 and α_2 are known, the defining of remaining geometry in the model of transmitter is significantly simplified as well as the further calculation.

Resolving of the equilibrium equations leads to the values of radial, normal forces and tangential normal forces on the tooth. The rigidity of the springs is known, and on the basis of their deformation, that is, displacements that occur at the contact of the belt and belt pulley it is possible to determine the friction forces on the points of the contact [18-19].

Depending on the point of the contact, the friction defines in the following way:

- **Friction in the contact of the belt inter-teeth and belt pulley top land**

$$F_{iT} = \Delta_t \cdot K_t \quad (4)$$

where: Δ_t - deformation at the contact of belt inter-teeth and belt pulley top land,

K_t - the rigidity of the spring at the contact of the belt inter-teeth and belt pulley top land.

- **Friction in the contact of the sides of belt teeth and belt pulley teeth**

$$F_{iB} = \Delta_b \cdot K_b \quad (5)$$

where: Δ_b - is deformation due to the contact of the sides of the tooth,

K_b - the rigidity of the spring on the sides of the belt teeth and belt pulley.

Along the envelope angle, the direction and intensity of the friction force change. The entire explanation that was given applies for drive belt pulley, while at driven belt pulley applies the opposite.

5. THE TIMING BELT NUMERICAL MODEL

In the modern approach to projecting, the use of simulation at the different levels of the projecting process can verify the function in the real conditions, the tension of the parts and ability of carrying the load. In recent years, modern software packages provide us with an opportunity to perform all those calculations on the different types of load fast and easy. For calculation and analysis of timing belt transmitter in this paper, at different values of the load, the finite elements method applies. The analysis of the impact of pre-tensioning on the load distribution at timing belts in this paper is analyzed in this paper by MKE integrated in 3D software package *Autodesk Inventor*. The analysis of the impact of pre-tensioning is performed for real timing belt drive, presented on Fig.1 [20,21].

The complete profile of the timing belt with belt pulley which is used in the analysis has been modeled and analyzed in 3D. Figure 6 presents the examination model of timing belt drive with the network of finite elements.

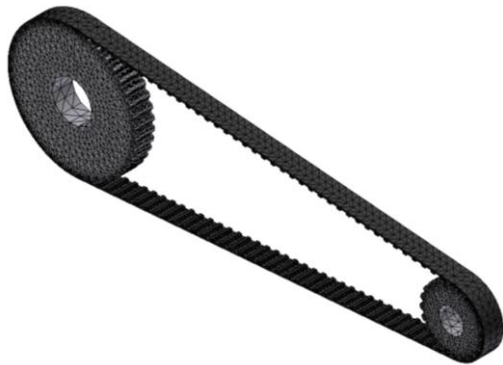

Figure 6. The network of finite elements on the timing belt drive

Spatial finite elements are used for the network. Steel is used as a material for belt pulleys, and for the belt, since it doesn't contain tractive element, the hard rubber is used.

Properties of the materials of the belt and belt pulley are presented in the Table 2.

Table 2. Basic properties of the material

Material	Young module	Poisson's coefficient.
Steel (belt pulley)	210 GPa	0,3
Hard rubber (belt)	10GPa	0,3

6. EXPERIMENT

How the pre-tensioning impacts the tension distribution shall be presented in the continuation of the paper. Namely, timing belt exposes to different values of the force of the pre-tensioning, and working environment of the Autodesk Inventor requires assigning of boundary conditions, that is, assigning of the load.

Values of basic parameter in operating conditions of timing belt drive are the number of revolutions of input shaft which is $n_1 = 1400 \text{ min}^{-1}$, while the torque on the input shaft is $M_1 = 7,504 \text{ Nm}$.

Basic technical data of timing belt drive are presented in Table 3.

Table 3. Basic technical data of timing belt drive

Parameter	Value
Number of teeth of drive belt pulley	$z_1 = 21$
Number of teeth of driven belt pulley	$z_2 = 42$
Number of belt teeth	$z_k = 112$
Designation of the belt	L
Belt step	$h = 9,525 \text{ [mm]}$
Width of the belt	$b = 19,050 \text{ [mm]}$
Profile angle of the belt	$\beta = 40^\circ$

On the drive pulley which is during the operating conditions exposed to the impact of the torque $M_1 = 7,504 \text{ Nm}$, is necessary to fix the movements along the tangential direction, as well as the radial movement of the belt pulley.

Driven pulley is exposed to pre-tensioning, that is, to tension along X movement in every other direction. For the examination of the impact of the pre-tensioning on the load distribution in timing belt, the values of the tension forces are in the interval from $F = 500\text{ N}$ to $F = 2000\text{ N}$.

Software package enables the defining of contact between the meshing teeth, and in the analysis the contact type *Separation* is used, where it involves the contact of contacting surfaces of the belt and belt pulley and their separation.

7. THE ANALYSIS OF THE RESULTS

Due to the action of the force of pre-tensioning, the tension condition of the belt changes in regard to the tension force. Load distribution in the belt is much more uniformed due to the increase of the force of the pre-tensioning, which can be seen on Fig.7 and 8 [20,21].

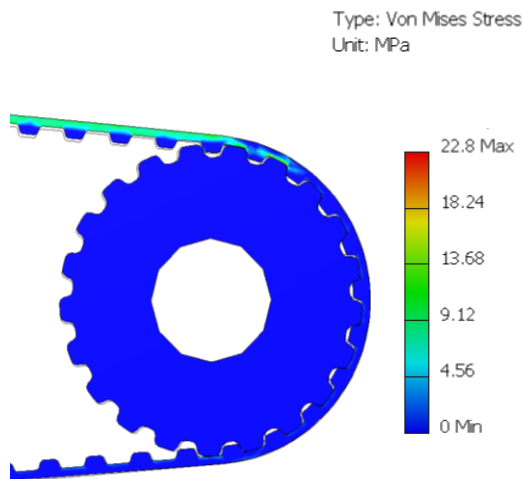

Figure 7. Load distribution at $F = 500\text{ N}$

Type: Von Mises Stress
Unit: MPa

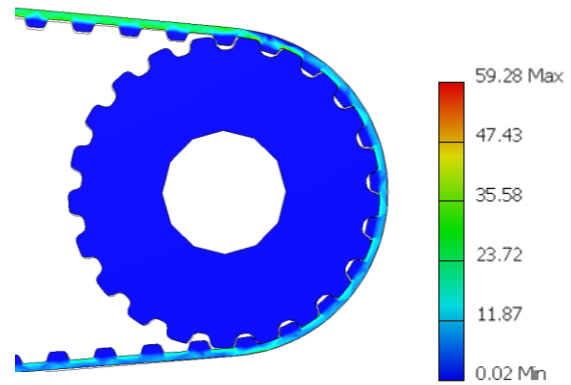

Figure 8. Load distribution at $F = 1000\text{ N}$

From the Fig.6 and 7 it can be seen that tension condition of the timing belt along polygonal profile of the driving pulley, due to the force of the pre-tensioning, is much more convenient at $F = 1000\text{ N}$ compared with the case when is $F = 500\text{ N}$. The presence of the force leads to a better meshing of belt teeth and belt pulley, a larger number of teeth participates in the transmission of the torque which leads to more uniform distribution of the load along the belt.

The attention should be paid to the value of the force of the pre-tensioning; it must not be too large since it would impact the overlarge overloading of EM, that is, the increase of pressure at contact points of the belt teeth and belt pulley, which certainly leads to damaging of the timing belt.

With the increasing of the pre-tensioning force the voltages on the teeth of the belt in mesh also increase.

The change of tension on the teeth of the belt in mesh due to the pre-tensioning force is presented on the diagram in Fig.9.

The impact of pre-tensioning force on load distribution

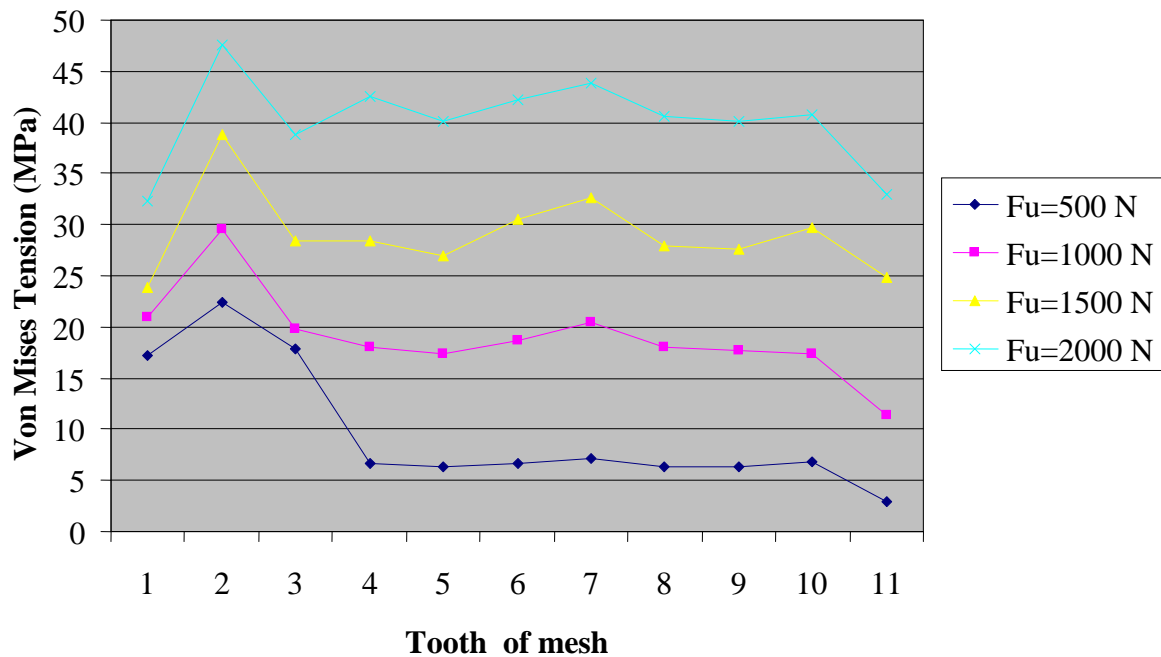

Figure 9. Load distribution on teeth in mesh due to the pre-tensioning force

From the diagram in the Fig. 9 can be seen that with the increasing of the value of pre-tensioning force the tensions on the belt teeth also increase. The results of the analysis due to the presence of the pre-tensioning force explain that the increases and decreases of the tension occur always on the same teeth. The first two teeth in mesh are the most overloaded and the value of the tension decrease as the belt moves from the tractive to free section.

8. CONCLUSION

Defining of load distribution at teeth in mesh is of great importance for the analysis of timing belt drives.

9. LITERATURE

- [1] Gerbert, G. Jönsson, H. Persson, U. & Stensson, G. (1978). Load distribution in timing belts, ASME.J.Mesh.Design 100(2), 208-215.
- [2] Stojanović, B. & Miloradović, N. (2009). Development of timing belt drives, Mobility & Vehicle Mechanics, 35(2), 31-36.
- [3] Tanasijević, S. (1994). Mechanical drives: chain drives, timing belt drives, cardanic drives, Yugoslav tribological society, Faculty of engineering from Kragujevac. (In Serbian).
- [4] Stojanović, B. Ivanović, L. & Miloradović, N. (2010). Testing of Timing Belt Drives, IMK-14, 37(4), 77-80.
- [5] Asonja, A. Cvetkovic, S. & Mikic, D. (2013). Testing of cardan shaft operating reliability in agricultural machines, Technical Diagnostics, 12(3), 12-19.
- [6] Stojanović, B. Tanasijević, S. Marjanović, N.Ivanović, L. & Blagojević, M. (2011). Wear as the Criterion of Mechanical Transmitters Working Life, J Balk Tribol Assoc, 17(2), 215-222.

- [7] Stojanović, B. Miloradović, N. Marjanović, N. Blagojević, M. & Marinković, A. (2011). Wear of Timing Belt Drives, *J Balk Tribol Assoc*, 17(2), 206-214.
- [8] Stojanović, B. Ivanović, L. & Blagojević, M. (2010). Friction and Wear in Timing Belt Drives, *Tribology in Industry*, 32(3), 33-40.
- [9] Stojanović, B. Tanasijević, S. & Miloradović, N. (2009). Tribomechanical Systems in Timing Belt Drives, *J Balk Tribol Assoc*, 15(4), 465-473.
- [10] Stojanović, B. Tanasijević, S. Marjanović, N. & Blagojević, M. (2011). Failure analysis of the timing belt drives, 12th International conference on Tribology SERBIATRIB'11, Kragujevac, Serbia, 210-215.
- [11] Stojanović, B. Miloradović, N. Marjanović, N. Blagojević, M. & Ivanović, L. (2011). Length Variation of Toothed Belt During Exploitation, *Strojniški vestnik*, 57(9), 648-654.
- [12] Stojanović, B. Miloradović, N. & Blagojević, M. (2009). Analysis of Tribological Processes at Timing Belt's Tooth Flank, *Tribology in Industry*, 31(3-4), 53-58.
- [13] Stojanovic, B. Ivanovic, L. & Ilic A. (2014). Experimental determination of timing belt height at inter-teeth, *Technical diagnostics*, 13(1), 5-10.
- [14] Stojanovic, B. & Ivanovic L. Tribomechanical systems in design, *J Balk Tribol Assoc*, 20(1), 25-34.
- [15] Stojanović, B. Babić, M. Marjanović, N. Ivanović, L. & Ilić, A. (2012). Tribomechanical Systems in Mechanical Power Transmitters, *J Balk Tribol Assoc*, 18(4), 497-506.
- [16] Milanović, I. Stojanović, B. Blagojević, M. & Marjanović, N. (2011). Influence of torque variation on timing belt drive's load distribution, The 7th International scientific conference IRMES 2011, 559-562.
- [17] Karolev, N. & Gold, P. (1995). Load distribution of timing belt drives transmitting variable torques, *Mech.Mach.Theory*, 30(4), 553-567.
- [18] Johannesson, T. & Distner, M. (2002). Dynamic Loading of Synchronous Belts, *ASME, Mechanical Design* 124, 79-85.
- [19] Callegari, M. & Cannella, F. (2001). Lumped parameter model of timing belt transmissions, AIMETA'01.
- [20] Autodesk inventor, software tutorial.
- [21] Milanović, I. (2010). Calculation and analysis of timing belt drives, Master thesis, Kragujevac.